

ANSAMBLU DE PRINDERE PE STALP CU BRATARA – AUB /tip stalp / *PILE GRIPPING BRACKET ASSEMBLY*

Stalpi vibrati- precomprimati / <i>Vibrated- prestressed piles</i>	a (mm)	b (mm)	Stalpi centrifugati / <i>Centrifugally- cast piles</i>	R (mm)
SE 4	180	215	SC 10.001	80
SE 10	265	370	SC 10.002	130
SE 11	325	430	SC 10.005	138

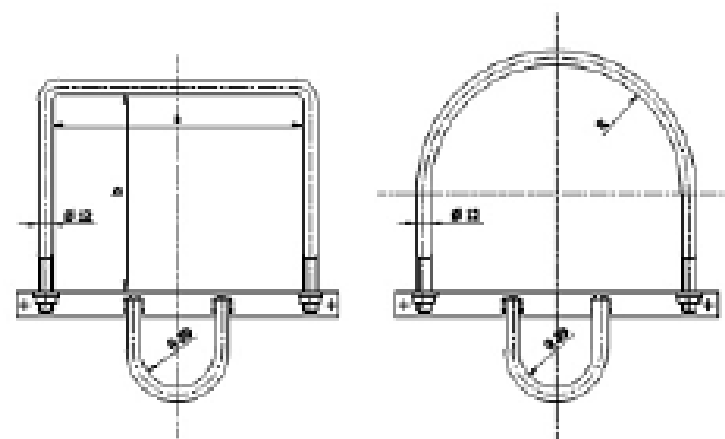

TIFA FILETATA – TF / *SCREWED ROD*

	L (mm)	Efort nominal orizontal <i>Horizontal rated strength</i> (daN)	Greutate <i>Weight</i> (kg)
TF SE 4	240	1100	0.255
TF SE 10	350		0.367
TF SE 11	400		0.378

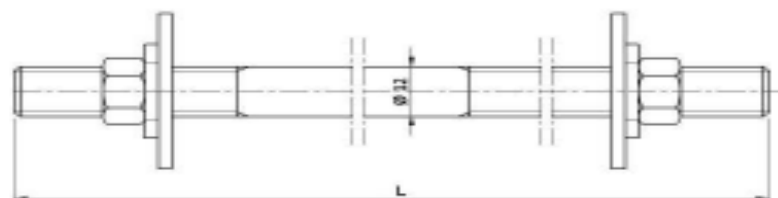

TIJA DE INTINDERE TI / *TENSION HOOK*

	A (mm)	B (mm)	Efort nominal orizontal <i>Horizontal rated strength</i> (daN)
TI SE 4	200	260	1100
TI SE 10	300	360	
TI SE 11	350	410	



TIJA DE SUSTINERE TS / *SUSPENSION HOOK*

	A (mm)	B (mm)	Efort nominal orizontal <i>Horizontal rated strength</i> (daN)
TS SE 4	250	330	1100
TS SE 10	350	430	
TS SE 11	400	480	

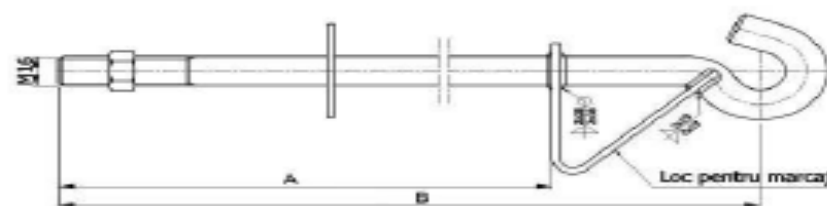

BRATARA DE SUSTINERE BRANSAMENT – BBS/ tip stalp
BRANCHING SUSPENSION BRACKET

Stalpi vibrati-precomprimati <i>Vibrated-prestressed piles</i>	a (mm)	b (mm)	Stalpi centrifugati <i>Centrifugally-cast piles</i>	D (mm)
SE 4	180	215	SC 10.001	170
SE 10	265	370	SC 10.002	265
SE 11	325	430	SC 10.005	285
			TC 15.014	380

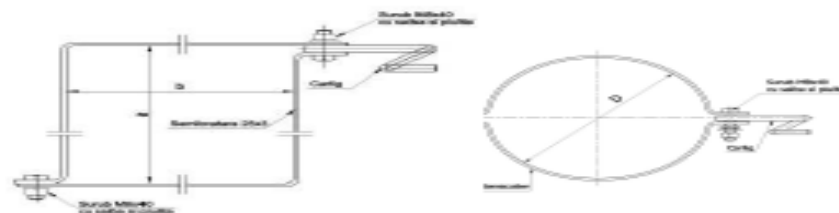

CONSOLA DE SUSTINERE CU BRATARA – CSB /tip stalp
SUSPENSION BRACKET

Stalpi vibrati-precomprimati <i>Vibrated-prestressed piles</i>	a (mm)	b (mm)	Stalpi centrifugati <i>Centrifugally-cast piles</i>	D (mm)
SE 4	170	170	SC 10.001	160
SE 10	272	310	SC 10.002	250
SE 11	325	400	SC 10.006	270
			TC 15.014	380

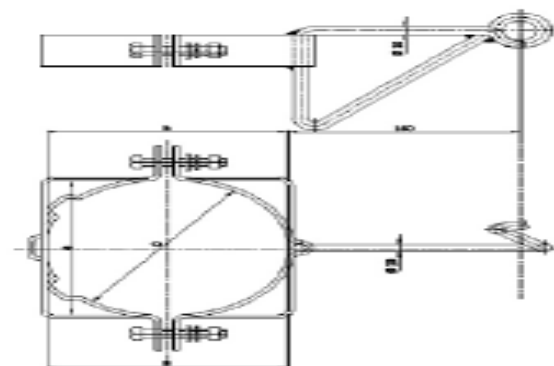

CONSOLA DE SUSTINERE – CS 300 / SUSPENSION CONSOLE

	Efort nominal orizontal <i>Horizontal rated strength</i> (daN)	Efort nominal vertical <i>Vertical rated strength</i> (daN)	Greutate <i>Weight</i> (kg)
CS 300	100	250	0.741

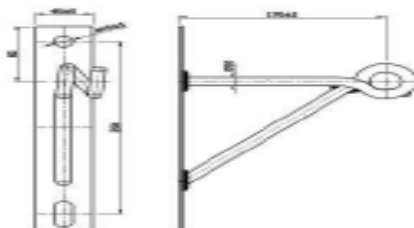

ANSAMBLU DE PRINDERE PE STALP – AU 750
PILE GRIPPING ASSEMBLY

	Efort nominal orizontal <i>Horizontal rated strength</i> (daN)	Greutate <i>Weight</i> (kg)
AU 750	750	0.71

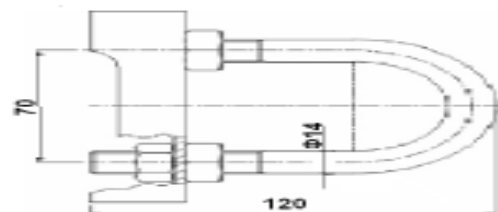

INTINZATOR RESEA IR 750 / DEAD-END HOOKS

	Efort nominal orizontal <i>Horizontal rated strength</i> (daN)	Greutate <i>Weight</i> (kg)
IR 750	750	0.63

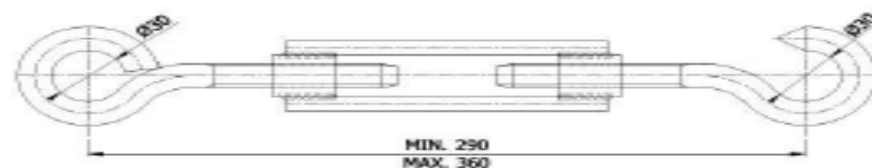

PRELUNGITOR P 750 / EXTENSION PIECE

	Efort nominal orizontal <i>Horizontal rated strength</i> (daN)	Greutate <i>Weight</i> (kg)
P 750	750	0.56

